

LMP-based Pricing for Energy Storage in Local Market to Facilitate PV Penetration

Xiaohu Yan, *Student Member*, Chenghong Gu, *Member, IEEE*, Furong Li, *Senior Member, IEEE*, and Zhaoyu Wang, *Member, IEEE*

Abstract—Increasing Photovoltaic (PV) penetration and low-carbon demand can potentially lead to two different flow peaks, generation and load, within distribution networks. This will not only constrain PV penetration but also pose serious threats to network reliability.

This paper uses energy storage (ES) to reduce system congestion cost caused by the two peaks by sending cost-reflective economic signals to affect ES operation in responding to network conditions. Firstly, a new charging and discharging (C/D) strategy based on Binary Search Method (BSM) is designed for ES, which responds to system congestion cost over time. Then, a novel pricing method, based on Locational Marginal Pricing (LMP), is designed for ES. The pricing model is derived by evaluating ES impact on the network power flows and congestions from the loss and congestion components in LMP. The impact is then converted into an hourly economic signal to reflect ES operation. The proposed ES C/D strategy and pricing methods are validated on a real local Grid Supply Point (GSP) area. Results show that the proposed LMP-based pricing is efficient to capture the feature of ES and provide signals for affecting its operation. This work can further increase network flexibility and the capability of networks to accommodate increasing PV penetration.

Index Terms— Congestion management, DG consumption, energy storage, pricing, LMP

I. INTRODUCTION

Since the majority of network assets were constructed in the last century, system congestion in the UK has increased due to the aging of the pre-planned and limited capacity of existing systems. The network is also constrained to a higher level and regularly due to the increase of renewable penetration especially within the distribution networks which host a large share of distributed generation. The cost due to wind curtailment and amount of wind curtailment exceeded £90 million and 1.3GWh in 2015 in the UK [1]. There are several papers focused on addressing congestion by utilising demand side responses, building high-voltage, direct current (HVDC) lines, using congestion management and installing energy storage. However, the use of demand side responses has high uncertainties [2, 3] and the associated cost for the HVDC is extremely high [4].

Energy storage (ES), as a promising technology, can increase renewable penetration by shifting the output at peak loading period temporally. The current capacity of ES is less than 200MW in the UK but it is expected to increase to 1.6GW by 2020 [5]. A large volume of research [6-8] has quantified the benefits of ES, such as improving network operating capabilities, lowering operation cost, and deferring/reducing network investments. Paper [9] proposes different ES strategies, but the complex characteristic matrices and lack of pricing method make it difficult to promote ES.

However, there are still many barriers obstructing the penetration of ES, as examined by many research and governing bodies in EU, US [10-12] and the UK [13, 14]. The major barriers of perceived importance are: i) absence of appropriate pricing methods for ES; ii) absence of appropriate charging/discharging (C/D) methods for ES with different ownership; iii) absence of ancillary markets for ES; and iv) lack of clarity regarding the operation of ES assets

In terms of *pricing approach*, an essential issue for ES penetration is that the pricing for ES is a vacancy [11]. Pricing is the strategy to recover the investment cost and operation cost of networks for network operators. The cost is allocated to all network users based on their impact on network investment and operation. There are two pricing schemes: network pricing and energy pricing. Network pricing is to recover network investment for system operators. The common methods include Investment Cost-related Pricing (ICRP) in Brazil [15], and Long-run incremental cost (LRIC) [16] in the UK. The main energy pricing method is Locational Marginal Pricing (LMP) to calculate energy costs at specific locations, which is utilised in the United States [17]. The current pricing schemes are only designed for traditional network users, generation and load. They are designed without considering ES and inappropriate for ES due to ESs integrating the two features of load and generation together. It is a significant issue that how to appropriately price ES as it uses the network for both importing and exporting energy. With an appropriate pricing method, an incentive will be awarded to ES if it can reduce network congestions, otherwise, it should be punished.

Furthermore, the impact on distribution networks from ES

The work is in part supported by the EPSRC project EP/M000141/1 and Chinese Scholarship Council.

X. Yan, C. Gu (corresponding author), and F. Li are with the Department of Electronic and Electrical Engineering, University of Bath, Bath BA2 7AY, U.K. (e-mail: x.yan@bath.ac.uk; c.gu@bath.ac.uk; f.li@bath.ac.uk). Zhaoyu Wang is with Department of Electrical and Computer Engineering Iowa State University, Ames, IA, US (email: wzy@iastate.edu).

varies with C/D methods and its ownership. Typically, there are three groups of ES owners: customers, distribution network operators (DNOs), and third parties [12, 14, 18]. If ES is owned by customers, it is normally used to respond to the time of use tariff for energy bill saving. If owned by DNOs, the ES is used to protect network infrastructures such as minimising the system peak demand and reducing congestion. If owned by a third party, it is operated to respond to the pricing signals to generate higher profits for the party. Currently, ES is a promising technology to provide ancillary services for the power system with increasing renewable energy and flexible demand [19, 20]. In [21-23], ESs are used to mitigate network congestions and manage power consumption by shifting load [24-27].

Due to the large penetration of renewables, the operation of ES becomes more complex. Generally, system peak demand appears during evening periods but there is potentially a reversed peak power flow during the daytime because of the high PV penetration at distribution network levels. The reversed flow can pose threats to the network reliability and complicate system protection. ES is a flexible resource to resolve system congestion and increase PV penetration by absorbing excessive PV output during daytime and releasing the stored electricity to meet demand during the evening.

Responding to these key issues in promoting ES, this paper proposes a novel pricing approach and C/D strategy for ES to facilitate PV penetration. Firstly, a new C/D method for ES system owned by the third party, which provides service to reduce system congestion. The discharging target is to reduce load caused congestion and the charging aim is to resolve congestion caused by PV generation. A designed BSM approach is utilised to operate ES to maximise congestion cost savings. Thereafter, a pricing method for ES is proposed based on the core concept of LMP to capture the impact of ES on system operation cost. There are two main reasons: 1) LMP can reflect the energy shifting feature of ES; 2) LMP can reflect the congestion cost appropriately [28]. The proposed approach will send price signals based on the unit cost savings of ES. The main contribution of the paper is that it: i) designs a BSM-based C/D operation method for ES to remove system congestion; ii) develops a novel LMP pricing scheme for ES; and iii) analyses the impact of ES on the network under high PV penetration.

The rest of the paper is organised as follows: Section II proposes the C/D model and pricing model for ES. Section III gives an outline of the whole process. In Section IV, the design C/D and pricing method are demonstrated on a local GSP distribution network. Section V draws conclusions.

II. LMP BASED PRICING MODEL FOR ENERGY STORAGE

This section designs the C/D method and pricing scheme for ESs to remove system congestion. The C/D method enables ESs to respond to system congestion and to mitigate it based on the BSM algorithm. The pricing method is developed based on LMP to quantify the impact of ESs on system operation.

A. Binary Search Method

BSM is a simplified mathematical programming to adjust the

energy amount in each C/D period for energy storage. In another word, the amount of energy that can be absorbed by ESs can be determined by BSM in a specific period. This can ensure that the loading level on the branch can achieve the minimum with a certain ES capacity. Normally, the binary search algorithm is only for the one-dimensional linear issues. This paper develops a BSM for two-dimensional planes which are the time periods and the energy amount in each period to adjust ES capacity during operation. Following ‘divide and conquer’ strategy, BSM is efficient to search a given token.

Fig.1 depicts the concept of BSM to determine the operation period and corresponded energy when ES cannot address all congestion (which is the area above the branch capacity). The branch capacity is represented by the red line in the figure. S_q is defined as the ES removed congestion (the energy absorbed by ES) and N is iteration number. W is defined as an interim variable to search the final branch loading level with ES operation. The assumed congestion on one branch that can be potentially removed by ES is defined as S , which is the area above W after ES operation.

In the first iteration (Fig.1.a, $N=1$), the W is randomly selected within the minimum and maximum of branch flow. For simplification, the average of the minimum and maximum is chosen. If $S > S_q$, it means that ES is not able to absorb all congestion of S , which means the assumed loading level should be in the upper half of W and the lower area of W should be eliminated. Then W is set as the new minimum. A new W will be calculated by taking the average of the maximum and new minimum, shown in Fig.1.b, $N=2$. If $S < S_q$, it means that ES can absorb all congestion of S and still has capacity left, the assumed loading level is between W and min in Fig.1.b. In this case, the W is set as the new maximum, shown in Fig.1.c, $N=3$. After n times of iterations, i.e. Fig.1.d, $N=n$, W will converge to a constant, where $S=S_q$. With ES operation, the branch flow is the final loading level.

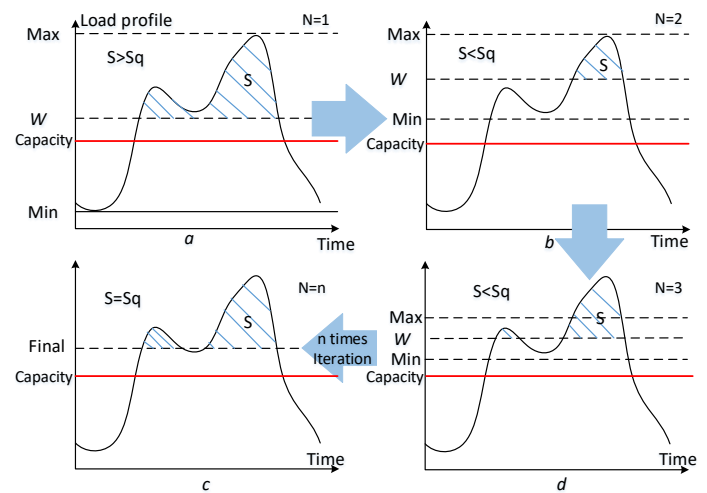

Fig.1. The proposed BSM method.

B. PV Output Modelling

The hourly power output of PV generation (P_{pv}) models [29] are introduced as:

$$P_{pv} = \gamma \times A_s \times G_0 \times \int_0^1 f(GG_0; \varphi_G; \sigma_G) \quad (1)$$

where the γ is the efficiency of the PV; A_s is the array surface area; G is the global horizontal irradiance; G_0 denote the corresponding extra-terrestrial irradiance; GG_0 represent G/G_0 with G scaled into $[0, 1]$; φ_G and σ_G can be estimated through fitting Beta distribution into the historical hourly solar irradiance data.

C. C/D Method Modelling

The designed C/D method is to respond to system congestions and the congestion cost (CC) is

$$CC = \sum_{t=1}^{24} \sum_{l=1}^n (pf_{ex,lt} - C_l) \times Uc \quad (l \in n) \quad (2)$$

where $pf_{ex,lt}$ denotes the power flow on the congested branch l ; C_l is the capacity of branch l ; Uc is the unit congestion cost.

The ES should be operated to minimise congestions cost in the system with ES which can be formulated as an optimisation model, represented by (3). The constraints are the branch power flow constraint, and node AC power flow constraint in (4-5). Constraint (6) is the conservation of energy constraints of ES operation. The capacity balance between two dispatch intervals is in (6a), and the capacity constraints for discharging and charging are in (6b) and (6c) respectively. The C/D rate constraints are in (6d) and (6e). The constraints of C/D cycles are provided in (6f) and (6g) denotes the SoC constraints.

$$\text{Min} \quad \sum_{t=1}^{24} \sum_{l=1}^n (CC_{ES_{tl}}) \quad (3)$$

$$\text{s. t.} \quad |pf_l| < C_l \quad (4)$$

$$P_k^G - P_k^L = \sum_{i=1}^N V_k V_i [G_{ki} \cos(\theta_k - \theta_i) + B_{ki} \sin(\theta_k - \theta_i)] \quad (5a)$$

$$Q_k^G - Q_k^L = \sum_{i=1}^N V_k V_i [G_{ki} \sin(\theta_k - \theta_i) + B_{ki} \cos(\theta_k - \theta_i)] \quad (5b)$$

$$\left\{ \begin{array}{l} \sum_{t=1}^{24} \sum_{l=1}^n (CES_{tl}) = \eta_d \sum_{t=1}^{24} \sum_{l=1}^n (DES_{tl}) \quad (6a) \\ Mis \times CE \leq \sum_{t=1}^{24} \sum_{l=1}^n (DES_{tl}) \leq Mas \times CE \quad (6b) \\ Mis \times CE \leq \sum_{t=1}^{24} \sum_{l=1}^n (CES_{tl}) \leq Mas \times CE \quad (6c) \\ \sum_{t=1}^{24} \sum_{l=1}^n (CES_{tl}) \leq Crate \quad (6d) \\ \sum_{t=1}^{24} \sum_{l=1}^n (DES_{tl}) \leq Crate \quad (6e) \\ cycle \leq maxdc \quad (6f) \\ Mis \leq SoC \leq Mas \quad (6g) \end{array} \right.$$

where, $CC_{ES_{tl}}$ is the system congestion with the proposed C/D operation at time t ; pf_l is the power flow on branch l . P_k^G, P_k^L, Q_k^G and Q_k^L are the active and reactive power for generation and load at node k , where $i, k \in N$ (N is node number); V is the node voltage with angle θ ; CE is ES capacity and CES_{tl} and DES_{tl} are charged and discharged energy; $Crate$ is the hourly maximum C/D rate constraint; $cycle$ is the daily cycle for ES and $maxdc$ is the maximum cycle times for ES; Mis and Mas are the minimum and maximum SoC status level constraints, which are normally 20% and 90% respectively; η_d is the discharging efficiency.

The requested ES capacity (ES_{tl}) in time t from branch l to mitigate the congestion can be represented as:

$$ES_{tl} = \frac{(pf_{ex,lt} - C_l) \times AC_PTDF_l}{\eta} \quad (7)$$

where η is the ES charging or discharging efficiency.

AC Power Transfer Distribution Factor (AC_PTDF) [30, 31] is introduced to select the branch l that has the largest impact on energy change resulting from ES. If the power change at bus m is P_m and caused power change on branch l (between busbars i and j) is ΔP_m , the AC_PTDF is

$$AC_PTDF_l = \frac{\Delta P_{ij}}{\Delta P_m} \quad (8)$$

D. Pricing for ES Modelling

The proposed LMP method seeks to capture the C/D actions of ESs on networks power flow. It is a locational pricing scheme to reflect the energy shifting characteristics of storage according to its operation. The LMP for ES, with predefined C/D methods, shows the pricing change in different time for its C/D actions. In general, LMP [32] contains three cost parts which are energy, loss, and congestion that is relative to the generation cost and the thermal limit of branches.

The LMP at bus i (λ_i) has three parts: 1) λ_r is the energy price for ES based on generation cost and the ES is treated as a load during charging; 2) λ_i^L is the marginal loss component of the nodal price; 3) λ_i^{Con} is the congestion component of the nodal price. They can be presented as:

$$LMP_i = \lambda_r + \lambda_i^L + \lambda_i^{Con} \quad (i \in N) \quad (9)$$

$$\lambda_r = \frac{dC_{ES}(P_{ES})}{dES_k} \quad (10)$$

$$\lambda_i^L = -\lambda_r \times LF_k = -\lambda_r \times \frac{\partial L_t}{\partial PF_i} \quad (11)$$

$$\lambda_i^{Con} = -\sum_{l=1}^n (\alpha_{l,i} \times TL_l) \quad (12)$$

where, $\alpha_{l,i}$ is the generation shift distribution factor (GSF); TL_l is the thermal constraint cost of line l which is the difference between energy costs in the system without and with branch capacity constraints; LF_k is the loss factor at bus k ; $C_{ES}(P_{ES})$ is the generation cost for ES due to its operation. ES_k is the current state of charge (SoC) of ES at bus k and L_t is the system MW loss.

For the loss component, the loss factor LF_k can be determined by loss L_t caused by ES, which can be derived from branch impedance and the power flow change in (13). The power flow change can be determined by the GSF and the ES hourly output or input denoted in (14). The GSF can be determined by the impedance of the system in (15).

$$L_t = \sum_{l=1}^n F_l^2 Z_l \quad (13)$$

$$F_l = \sum_{i=1}^N \alpha_{l,k} ES_{tk} \quad (14)$$

$$\alpha_{l,k} = \left(\frac{Z_{ik} - Z_{jk}}{Z_l} \right) \quad (15)$$

where F_l is the power flow of line l caused by the ES, ES_{tk} is

ES energy output/input at time t ; Z_l is the impedance of line l , Z_{ik} and Z_{jk} are the self-impedance of the sending and receiving bus of l .

By combining (13-14), the loss factor can be derived as:

$$LF_k = \frac{\partial(\alpha_{l,k}ES_{tk})^2 Z_l}{\partial ES_{tk}} = 2 \sum_{l=1}^n (\alpha_{l,k}^2 ES_{tk} Z_l) \quad (16)$$

In the congestion component, constraint cost or the shadow price of branch l can be determined by the power flow and total cost change due to the constraints of the branches.

$$TL_l = \frac{\text{total cost change}}{\text{power flow change}} \quad (17)$$

Therefore, the LMP for ES can be derived as:

$$LMP_{S_t} = \lambda_r \times \left(1 - \frac{\partial L_t}{\partial ES_{tk}}\right) - \sum_{l=1}^n (\alpha_{l,i} \times TL_l) \quad (18)$$

Since the LMP for ES is the partial derivative of ES output, the LMP for load is the original LMP equations where the partial derivative is with respect to the load [28]. For the LMP of load, the three parts in the LMP should be modified as follow: λ_r , the first part, is the partial derivative of generation cost to the load at the busbars; λ_i^L , the second part, should be the partial derivative of system losses to the load at busbars; λ_i^{Con} , the third part, should be the partial derivative of congestions to the load. Thus, the LMP for load is (19):

$$LMP_{tk} = \lambda_r \times \left(1 - \frac{\partial L_t}{\partial D_{tk}}\right) - \sum_{l=1}^n (\alpha_{l,i} \times TL_l) \quad (19)$$

where D_{tk} is the load at busbar k at time t .

III. THE WHOLE PROCESS

There are two main stages in setting pricing signals to ESs, which are C/D method design and pricing method development.

A. Stage 1: C/D Method Design

In this stage, ES is assumed to respond to system congestion cost. Fig. 2 depicts the process of ES C/D strategy. There are three major steps to design the C/D methods: i) Determining power transfer distribution factor (PTDF) matrix to detect the power flow change resulting from ES operation; ii) Matching the ES capacity with the congestion request to ensure power flow on the branch can achieve the lowest level with certain ES capacity; iii) equalising the charged and discharged capacity.

▪ Step 1: Determining PTDF matrix

In this step, with the input system parameters and demand and generation data, the PTDF matrix of the system is determined by MATPOWER [33]. PTDF is one method to quantify the impact of nodal generation/demand on branches in order to find and curtail the most influential generation/demand based on the technical aspect. Although PTDF is derived from DC load flow where energy loss is ignored, it can be used for AC power flow analysis due to the small system losses, such as [30, 34, 35]. Then, the system congestion period and amount from different branches can be determined by running power

flow. Traditionally, the constraints management obeys the last-on-first-off (LOFO) rule [26], which means the last generator to produce electricity will be the first to be curtailed when overloading occurs. This is a very basic strategy, and neither economic nor can reflect the impact of generation on branches. Pro Rata in [36] is another method to allocate network congestion. It quantifies the impact of nodal generation on branches and allocates the curtailment equally among all installed generators based on their rated capacity. In this paper, PTDF is used because of its simplicity and wide utilisation [26].

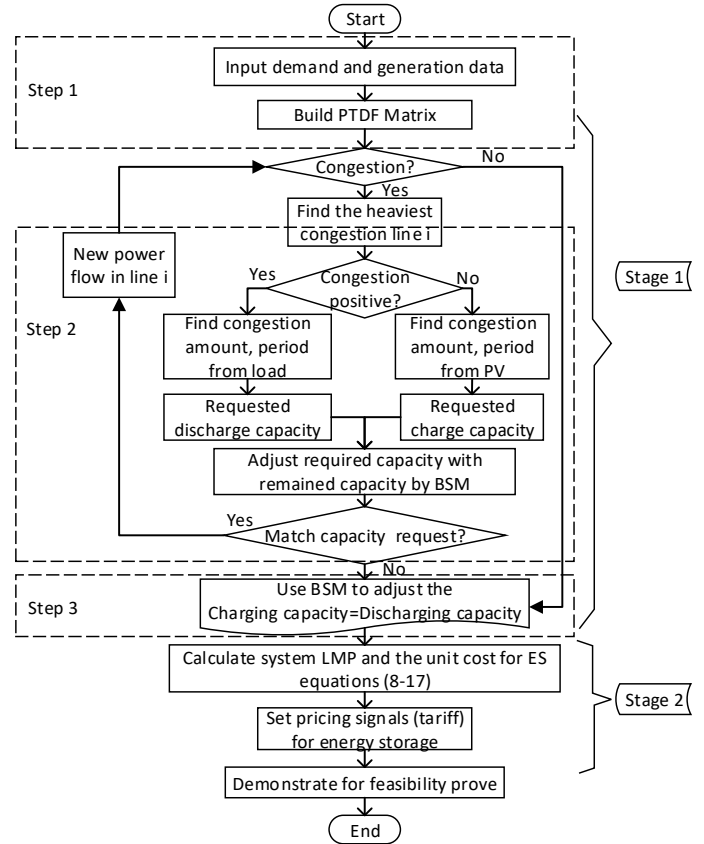

Fig. 2. Flowchart for the whole process

▪ Step 2: Matching ES capacity with congestion request

In this step, the operation period and the amount of each time of ES will be determined. The branch (l_0) with the heaviest congestion level is found and targeted. It assumes that the load caused congestion is positive and PV caused congestion is negative due to the reversed power flow. This helps the operator to make a decision to charge or discharge the ES to mitigate the congestion. The congestion amount that targeted to address can be converted to the requested capacity of ES. If there are several ESs, the one which can provide the most contribution to reduce the congestion is firstly selected based on PTDF. If the capacity of ES is sufficient to address the congestion on this branch, the remained capacity is used to address congestions on other branches which are selected based on the perceived loading level from high to low. The algorithm returns to the beginning of Step 2 until the ES capacity fully used or all the congestion in the system is resolved. If ES capacity is not sufficient to address all congestions, the BSM is applied to determine the

maximum congestion that can be absorbed by the ES to ensure it is fully charged or discharged.

▪ *Step 3: Equalising charged and discharged capacity of ES*

For ES, the charged and discharged energy amount should be the same during a daily cycle, which is a common constraint for ES. However, there will be an imbalance between the two if the congestions are mitigated by ES partial charging or discharging. To meet equality constraints, the BSM is applied to calculate the needed energy based on the loading level of the congested branches. After adjustment, the power flow can be evaluated, which provides the data for LMP calculation.

B. Stage 2: Pricing Method Design

The pricing method is designed based on LMP which is calculated from the system with ES under proposed operation strategy. The ES is treated as a generator during its discharging period and as a load during its charging period. There are three key elements in the pricing signal for ES which are energy cost, loss and congestion. These three elements reflect the impact of ES on the power flow change in the system.

If the pricing signal for ES is negative it means the ES should be rewarded for its operation of reducing system congestion cost. Otherwise, ES should be penalised due to the intensified power flow and increased congestion cost resulting from its operation.

IV. CASE STUDY

The proposed models are demonstrated on a practical local GSP area taken from the U.K. distribution network in Fig.3 [37]. This study modifies it by adding ES at buses 1007 and 1006. It assumes that ES capacity is 20MWh, asset lifespan is 40 years and annuity factor is 0.0831 [16]. A typical load growth of 2% and a discount rate of 5.6% are chosen. The generation on busbar 1005 (G1) is a PV farm, which supports domestic demand on the other busbars during day time. Based on (1), the output of PV is depicted in Fig.4, with a peak of 40MW. An auxiliary generation is located at 1005 to support the PV farm. G2 is at busbar 1003 and the upstream system is treated as G1008. In order to simplify the analysis, the following assumptions are adopted: i) the losses of energy storage is zero; ii) the minimum and maximum SOC levels are 0% and 100% respectively; iii) the daily storage cycle is one.

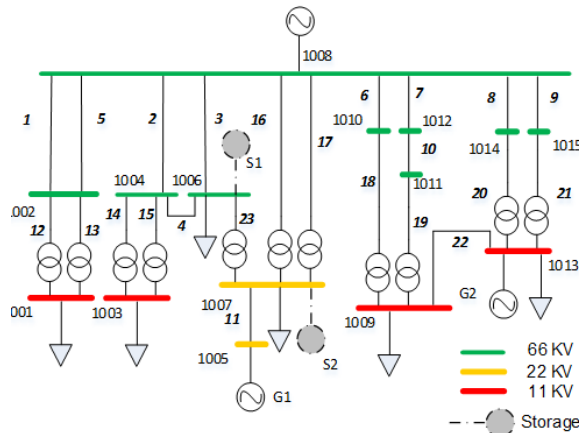

Fig.3. A Grid Supply Point (GSP) area test system.

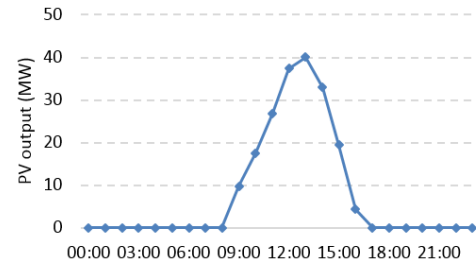

Fig.4. A daily PV output curve.

The energy cost for the distributed generators are:

$$G_{1008} = 0.03P_{1008}^2 + 30P_{1008} \quad (19)$$

$$G_1 = 0.01P_1^2 + 10P_1 \quad (0 \leq P_1 \leq 80\text{MW}) \quad (20)$$

$$G_2 = 0.01P_2^2 + 20P_2 \quad (0 \leq P_2 \leq 80\text{MW}) \quad (21)$$

Due to the large scale of the PTDF matrix, this section only illustrates that of busbars 1007 and 1006 with respect to corresponding branches in Table I. It can be observed that the load in 1006 poses a large impact to branches No.2, No.3 and No.4 with big PTDF elements which are around 0.5. But it poses slightly impact to branches No.16, No.17 and No.23 with small PTDF elements. Since the PTDF elements for No.16 and No.17 are negative and that for branch No.23 is positive, which means if the congestion decreases on No.16 and No.17, the power flow will be increased in branch No.23 due to the ES operation at busbar 1006. This means it will increase the congestion if ES charges during the PV driven period. The load at 1007 poses a large impact to branches No.16 and No.23, but slightly impact on branches No.2 and No.3.

TABLE I
THE PTDF MATRIX FOR GSP SYSTEM

Branch \ Bus	Bus				
	1006	1007	Branch	1006	1007
No. 2	0.76	0.24	No. 16	0.02	0.34
No. 3	0.85	0.27	No. 17	0.02	0.31
No. 4	0.81	0.27	No. 23	-0.07	0.26

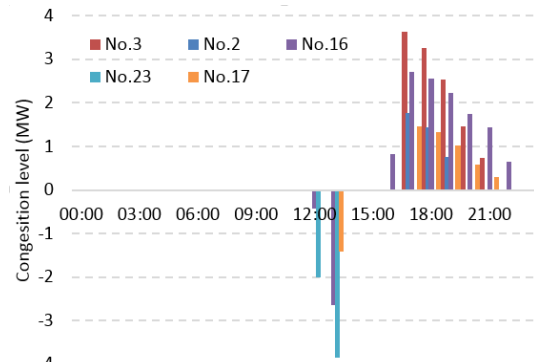

Fig.5. The congestion in different periods

In Fig.5, the load caused congestion on branches is shown in the positive value and the generation caused congestion is shown in the negative value due to generation dominated power flow is reversed. The load caused congestion is positive from 16:00~22:00 and the generation caused congestion is from 12:00 to 13:00. There are five congested branches, where branches No.2 and No.3 are purely load caused congestion and

branch No.23 has generation caused congestions. The congestions on branches No.16 and No.17 are caused by both generation and load due to network structure. The highest load caused congestion is 3.6MW on branch No.3 at 17:00 and the highest generation caused congestion is 3.9MW on branch No.23 at 13:00. Since branches No.16 and No.17 have the same location and parameters, the loading level and ES impact are similar. Thus, branch No.16 is chosen for a simplified demonstration in the following parts.

A. ES locates at busbar 1006

Fig.6 shows the C/D periods and the SoC of the ES, where the positive value is discharging and the negative value is charging. The discharging aims to minimise the load caused congestion cost and the charging targets to minimise the generation caused congestion. However, the congestion on branch No.23 will be intensified when the ES reduces the congestion from branches No.16 and No.17. Combined with the PTD matrix, the factor for branches No.16 and No.17 are negative (-0.02) and for No. 23 is positive (0.04), which justifies the fact. In addition, the factor for No.23 is doubled than that those for No.16 and No.17, which means ES charging will lead the increased power flow doubled than the decreased flow of branches No.16 and No.17. Therefore, the charging for ES at busbar 1006 is to maintain the congestion level of the system, which means it charges during the period with low loading level. As seen, the ES charges during: i) 10:00~11:00, with SoC increasing from 0% to 35%; ii) and 13:00~15:00 with SoC increasing from 35% to 100%, where the max charging rate is 10.3MW/h. The discharging period is 17:00~21:00 and the maximum discharging rate is 6.6MW/h. The daily charged and discharged amount is 20MWh.

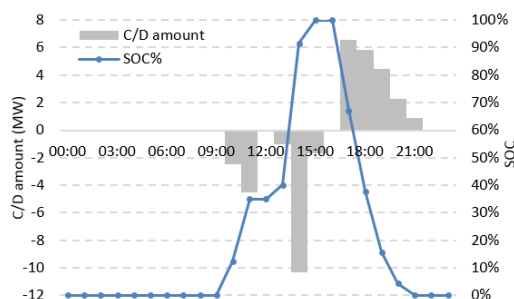

Fig.6. The operation of ES at 1006

Fig.7 shows the power flow change along branches No.3 and No.16 without and with ES C/D at busbar 1006. The solid lines denote the original power flow along these branches and the dash lines are the power flows after ES operation. During the charging period, the negative peak caused by generation has not decreased. Since the total congestion cost will increase from other branches, such as branch No.23, the ES does not charge at this point. The loading level on branch No.16 is slightly increased during the charging period. The discharging action of ES almost poses no impact to the power flow on branch No.16 due to the small PTD element (-0.02). As seen, during the discharge period, the power flow is decreased from 34.6MW to 31.4MW at the peak point on branch No.3, which helps to reduce the congestion cost on this branch.

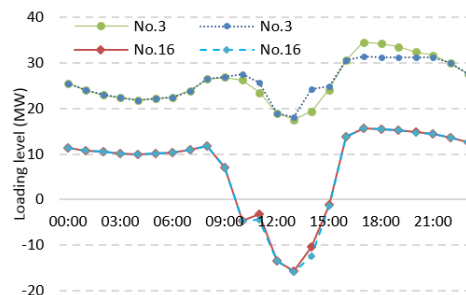

Fig.7. Power flow change on the overloading branches

B. ES locates at busbar 1007

The Fig.8 shows the C/D period and the SoC of the ES that located at busbar 1007. The positive value represents ES discharging and the negative represents charging. As seen, the ES charges during 12:00~13:00, the maximum charging rate is 12.6MW/h. The discharging period is 18:00~21:00, the maximum discharging rate is 11.7MW/h. The total charged and discharged amount is 20MWh.

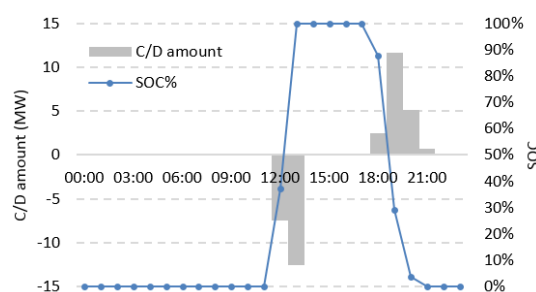

Fig.8. The operation of ES at 1007

The Fig.9 shows the power flow changes under proposed C/D method at busbar 1007. Although the load caused congestion and the generation caused congestion are all reduced, which means the congestion cost is reduced.

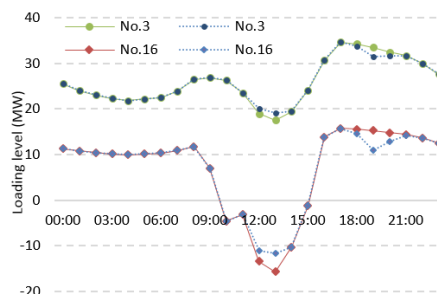

Fig.9. Power flow on the overloading branches

C. System congestion change

The congestion period and amount without ES are summarised in Table II. Branch No.16 has the congestion of 15.2MWh within 9 hours, where generation caused congestion is 12.2MWh in 7 hours and load caused congestion is 3.1MWh in 2 hours. Branch No. 23 has the congestion of 5.9MWh in 2 hours caused by generation. To reduce the maximum of the congestion cost, the priority of ES operation is to discharge to reduce load caused congestion for branch No.16 and charge to reduce the generation caused congestion on branch No.23.

With ES operation at busbar 1006, the total congestion cost is reduced, although the congestion is not completely removed

due to ES capacity constraint. ES contributes more to congestion reduction at branches No. 2 and No. 3, which decreases from 4.0MWh to 0MWh and from 11.7MWh to 1.7MWh respectively. For branch No.16, the congestion only decreases 0.3MWh because of the small PTDF element. Although the ES charging at busbar 1006 causes the congestion to increase 0.1MWh at branch No.23, the total congestion cost decreases because it reduces more for branches No.2 and No.3. The total congestion declines from 42.8MWh to 28.4MWh. With ES operation at busbar 1007, the congestion on branch No.23 reduces from 5.87MWh to 0.4MWh. The load caused congestion declines from 11.7 MWh to 8.1 MWh on branch No.3 and the generation caused congestion declines from 15.2MWh to 7.0MWh on branch No. 16. The total congestion declines from 42.8MWh to 20.3MWh. By comparing with the cases of ES at different locations, the ES at busbar 1007 has better performance, removing more system congestions.

TABLE II
THE CONGESTION LENGTH AND AMOUNT WITH ES AT BUSBAR 1006

Branch		No.2	No.3	No.16	No.17	No.23
No ES status	Length (hour)	3	4	9	6	2
	Amount (MWh)	4.0	11.6	15.2	6.1	5.9
ES at 1006	Length (hour)	0	5	9	6	3
	Amount (MWh)	0	1.7	14.9	5.8	6.0
ES at 1007	Length (hour)	2	5	5	3	1
	Amount (MWh)	2.8	8.1	7.0	2.0	0.4

D. Load's LMP change resulting from ES

The LMP from different busbars at 17:00 is shown in Fig.10. Busbar 1003 has the highest LMP, which is £80/MWh. The LMPs are almost the same at busbars 1007 to busbar 1013, which are around £55/MWh.

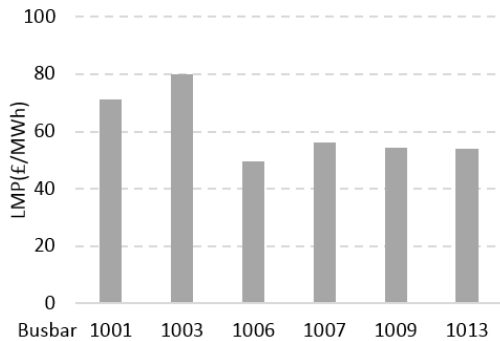

Fig.10. The LMP at different busbars

The hourly LMP for busbars 1006 and 1007 with and without ES are shown in Table III. Corresponding to (11-12), the loss factor and congestion element from the LMP of these two busbars are depicted in Fig.11 and Table IV. The LMP at busbar 1007 is higher due to the large value of losses and congestion. The LMP for busbar 1007 at 19:00 is £53.85/MWh, which reduces to £46.41/MWh after ES operation. The LMP for busbar 1007 is negative during 10:00 to 15:00 because the load can reduce the power flow during this period, which means it should be rewarded. The LMP changes from around -£48/MWh to -£49/MWh with ES operation, indicating that the ES operation not only can reduce system congestion but also increases the profits from customers.

At busbar1006, although the load can release the power flow at several branches, the LMP is positive over the day due to load at busbar 1006 only intensifies the power flows on all the branches. At 10:00, during ES charging, the LMP increases from £43.77/MWh to £45.7/MWh. It reduces from around £48/MWh to £45/MWh during ES discharging period.

TABLE III
DAILY LMP OF DIFFERENT BUSBARS IN THE SYSTEM (£/MWH)

Time	LMP at Bus 1006		LMP at Bus1007	
	No ES	With ES	No ES	With ES
00:00	44.42	44.4	48.80	48.80
01:00	43.35	43.3	47.49	47.49
02:00	42.55	42.5	46.52	46.52
03:00	41.51	41.5	45.28	45.28
04:00	41.00	41.0	44.69	44.69
05:00	41.69	41.7	45.49	45.49
06:00	39.83	39.8	43.50	43.50
07:00	41.90	41.9	45.94	45.94
08:00	43.26	43.3	47.66	47.66
09:00	45.47	45.5	50.67	50.67
10:00	43.77	45.7	-49.24	-49.24
11:00	43.98	47.3	-49.38	-49.38
12:00	41.74	41.7	-46.27	-50.28
13:00	41.09	42.0	-45.87	-50.50
14:00	42.37	49.4	-47.21	-47.21
15:00	44.77	46.1	-50.02	-50.02
16:00	46.36	46.4	52.00	52.00
17:00	49.64	44.8	56.16	56.16
18:00	48.87	44.6	55.25	52.66
19:00	47.71	44.6	53.85	46.41
20:00	47.24	45.7	53.19	49.24
21:00	47.01	46.5	52.84	51.21
22:00	44.35	44.4	49.65	49.65
23:00	45.12	45.1	50.19	50.19

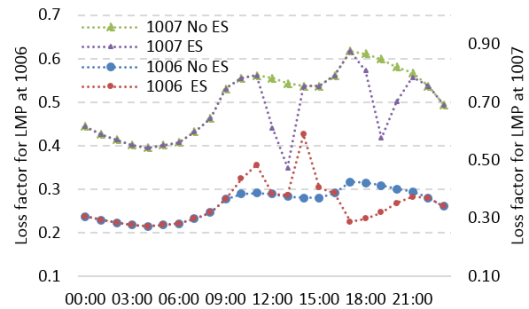

Fig.11. Loss factor (LF_k) change over time

Fig.11 shows the factors (LF_k) of the losses element. For the ES at busbar 1006, the factor is lower during the discharging period and it is higher during the charging period. This proves that the ES at busbar 1006 can release the power flow in discharging period but it intensified the power flow during its charging period where this factor reduces from 0.43 to 0.29 at 17:00. For the ES at busbar 1007, the factor with ES operation is always lower than that without ES operation during both C/D period. This proves that both C/D operation of the ES at busbar 1007 can reduce the power flow during both the generation and load caused congestion periods.

The congestion element (λ_i^{Con}) is shown in Table IV and two points are selected from C/D period due to the large scale of the daily matrix. Specifically, for ES at busbar 1006, at 13:00 and the discharging period, it can reduce the congestion element from 1.06 to £0.95/MWh. The congestion element can reduce more if the ES located at busbar 1007, from £0.95/MWh to -

£2.21/MWh during discharging period and 13:00.

TABLE IV
CONGESTION ELEMENT CHANGE (£/MWh)

	12:00	13:00	19:00	20:00
No ES at bus 1006	1.55	1.22	1.06	1.06
ES at bus 1006	1.55	0.95	0.95	0.95
No ES at bus 1007	1.76	0.95	0.95	0.95
ES at bus 1007	1.29	-2.21	-2.21	-2.21

E. LMP for ES

The hourly LMPs for ES at busbar 1006 and 1007 are shown in Fig.12 and 13. If the price is negative, the ES should be rewarded by DNOs because of power flow release, vice versa.

For the ES located at 1006, it is rewarded for load caused congestion reduction but punished from its charging. Although the congestion on branch No. 23 can be released by the ES, it aggravates the congestion levels in more branches. Therefore, the ES is punished for its charging from 10:00 to 15:00 and the tariff is around £28/MWh. The ES is rewarded during its discharging period from 17:00 to 21:00 around £40/MWh.

For the ES located at 1007, it is rewarded for both load and generation caused congestion reduction, which means it is rewarded in both C/D periods. The peak profit is £79/MWh at 19:00 and the average reward for ES during the discharging period is around £75.6/MWh which is 1.6 times of the LMP at this busbar. The reward for the reduction of generation caused congestion is around £65/MWh which is lower than that in load caused congestion period. This is because the load caused congestion is much more expensive than generation caused congestions.

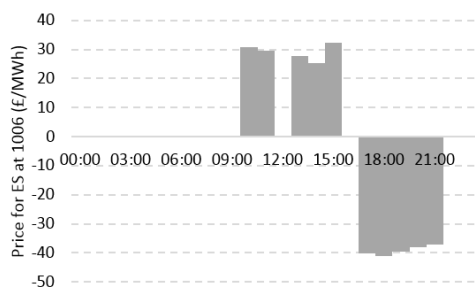

Fig.12. Price for ES located at 1006 of the day

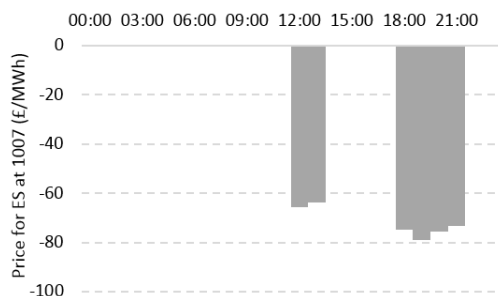

Fig.13. Price for ES located at 1007 of the day

Generally, the ES can gain more benefits located at busbar 1007. The reward is relatively small during the discharging period if the ES located at busbar 1006. This is because the ES may increase the power flow along some branches (such as branch No. 23) although the total congestion is reduced.

V. CONCLUSIONS

This paper designs a novel LMP based pricing scheme for ES to reflect its impact on network operation. It can help network operators to reward or penalise ES based on the impact of networks and generation. Through the extensive demonstration, the following key findings are obtained:

- The pricing method developed based on LMP can transfer network congestion and power flow into pricing signals to guide the operation of ES effectively;
- The appropriate operation of ES can reduce the total LMP of the system. The ES can obtain more than 1.5 times LMP during the peak periods caused by load;
- The location of ES that has large PTDF to the heaviest congestion branch has performance higher influence on congestion cost reduction than those with a small PTDF.
- Although energy cost is not reduced, loss and congestion element in LMP can be reduced with proposed ES operation.

This work is beneficial to further increase the capability of distribution networks to accommodate increasing PV penetration. In addition, it provides an economic signal for further analysis of ESs in the local energy market to facilitate renewable penetration. In the future work, more sophisticated optimisation models will be designed to obtain C/D strategies and more practical constraints on ES will be considered in LMP pricing for storage.

REFERENCES

- [1] E. Mearns, "UK Wind Constraint Payments," <http://euanmearns.com/uk-wind-constraint-payments/>, 2016.
- [2] A. N. M. M. Haque, P. H. Nguyen, F. W. Bliet, and J. G. Slootweg, "Demand response for real-time congestion management incorporating dynamic thermal overloading cost," *Sustainable Energy, Grids and Networks*, vol. 10, pp. 65-74, 6/ 2017.
- [3] S. Huang, Q. Wu, Z. Liu, and A. H. Nielsen, "Review of congestion management methods for distribution networks with high penetration of distributed energy resources," in *IEEE PES Innovative Smart Grid Technologies, Europe*, 2014, pp. 1-6.
- [4] M. A. Hualei Wang and M. A. Redfern, "The advantages and disadvantages of using HVDC to interconnect AC networks," ed. 2010, pp. 1-5.
- [5] BusinessGreen, "UK energy storage tipped to exceed 1.6GW by 2020," <http://www.businessgreen.com/bg/analysis/2442158/uk-energy-storage-tipped-to-exceed-16gw-by-2020>, 2016.
- [6] H. Akhavan-Hejazi and H. Mohsenian-Rad, "A stochastic programming framework for optimal storage bidding in energy and reserve markets," in *Innovative Smart Grid Technologies (ISGT), 2013 IEEE PES*, 2013, pp. 1-6.
- [7] B. Daryanian, R. E. Bohn, and R. D. Tabors, "Optimal demand-side response to electricity spot prices for storage-type customers," *IEEE Transactions on Power Systems*, vol. 4, pp. 897-903, 1989.
- [8] T. Jiang, Y. Cao, L. Yu, and Z. Wang, "Load Shaping Strategy Based on Energy Storage and Dynamic Pricing in Smart Grid," *IEEE Transactions on Smart Grid*, vol. 5, pp. 2868-2876, 2014.
- [9] X. Luo, J. Wang, M. Dooner, and J. Clarke, "Overview of current development in electrical energy storage technologies and the application potential in power system operation," *Applied Energy*, vol. 137, pp. 511-536, 2015.
- [10] E.-f. project, "Regulatory barriers to energy storage deployment: the UK perspective," <http://www.restless.org.uk/>, 2016.
- [11] U.S. Department of Energy "Grid Energy Storage," <https://energy.gov/>, 2013.
- [12] E. Parliament, "Energy Storage: Which Market Designs and Regulatory Incentives Are Needed?," [http://www.europarl.europa.eu/RegData/etudes/STUD/2015/563469/IPO_L_STU\(2015\)563469_EN.pdf](http://www.europarl.europa.eu/RegData/etudes/STUD/2015/563469/IPO_L_STU(2015)563469_EN.pdf), 2015.

[13]Ofgem, "A SMART, FLEXIBLE ENERGY SYSTEM," <https://www.gov.uk/government/consultations/call-for-evidence-a-smart-flexible-energy-system>, 2016.

[14]Gov.uk, "Energy Storage Use Cases (DNV GL for BEIS)," https://www.gov.uk/government/uploads/system/uploads/attachment_data/file/554467/Energy_Storage_Use_Cases.pdf, 2016.

[15]L. M. Marangon Lima and J. W. Marangon Lima, "Invested Related Pricing for Transmission Use: Drawbacks and Improvements in Brazil," ed, 2007, pp. 988-993.

[16]F. Li and D. L. Tolley, "Long-run incremental cost pricing based on unused capacity," *Power Systems, IEEE Transactions on*, vol. 22, pp. 1683-1689, 2007.

[17]L. Fangxing, "DCOPF- Based LMP Simulation: Algorithm, Comparison With ACOPF, and Sensitivity," *IEEE Transactions on Power Systems*, vol. 22, pp. 1475-1486, 2007.

[18]U. P. NETWORKS, "The Business Case of Storage," <http://innovation.ukpowernetworks.co.uk/innovation/en/>, 2016.

[19]M. Chazarra, J. I. Pérez-Díaz, and J. García-González, "Optimal Energy and Reserve Scheduling of Pumped-Storage Power Plants Considering Hydraulic Short-Circuit Operation," *IEEE Transactions on Power Systems*, vol. 32, pp. 344-353, 2017.

[20]L. S. Vargas, G. Bustos-Turu, and F. Larraín, "Wind Power Curtailment and Energy Storage in Transmission Congestion Management Considering Power Plants Ramp Rates," *IEEE Transactions on Power Systems*, vol. 30, pp. 2498-2506, 2015.

[21]C. Shao, X. Wang, M. Shahidepour, X. Wang, and B. Wang, "Partial Decomposition for Distributed Electric Vehicle Charging Control Considering Electric Power Grid Congestion," *IEEE Transactions on Smart Grid*, vol. 8, pp. 75-83, 2017.

[22]S. Huang, Q. Wu, L. Cheng, Z. Liu, and H. Zhao, "Uncertainty Management of Dynamic Tariff Method for Congestion Management in Distribution Networks," *IEEE Transactions on Power Systems*, vol. 31, pp. 4340-4347, 2016.

[23]J. D. Lyon, K. W. Hedman, and M. Zhang, "Reserve Requirements to Efficiently Manage Intra-Zonal Congestion," *IEEE Transactions on Power Systems*, vol. 29, pp. 251-258, 2014.

[24]J. H. Teng, S. W. Luan, D. J. Lee, and Y. Q. Huang, "Optimal Charging/Discharging Scheduling of Battery Storage Systems for Distribution Systems Interconnected With Sizeable PV Generation Systems," *IEEE Transactions on Power Systems*, vol. 28, pp. 1425-1433, 2013.

[25]R. C. Leou, "Optimal Charging/Discharging Control for Electric Vehicles Considering Power System Constraints and Operation Costs," *IEEE Transactions on Power Systems*, vol. 31, pp. 1854-1860, 2016.

[26]L. Zhou, F. Li, C. Gu, Z. Hu, and S. L. Blond, "Cost/Benefit Assessment of a Smart Distribution System With Intelligent Electric Vehicle Charging," *IEEE Transactions on Smart Grid*, vol. 5, pp. 839-847, 2014.

[27]Z. Wang, F. Li, and Z. Li, "Active household energy storage management in distribution networks to facilitate demand side response," in *2012 IEEE Power and Energy Society General Meeting*, 2012, pp. 1-6.

[28]J. B. Cardell, "Marginal Loss Pricing for Hours With Transmission Congestion," *IEEE Transactions on Power Systems*, vol. 22, pp. 1466-1474, 2007.

[29]H. Long, M. Eghlimi, and Z. Zhang, "Configuration Optimization and Analysis of a Large Scale PV/Wind System," *IEEE Transactions on Sustainable Energy*, vol. 8, pp. 84-93, 2017.

[30]S. C. S. Ashwani Kumar, "AC Power Transfer Distribution Factors for Allocating Power Transactions in a Deregulated Market," *IEEE Power Engineering Review*, vol. 22, pp. pp. 42-43, 2002.

[31]A. K. Sharma and J. Kumar, "ACPTDF for Multi-transactions and ATC Determination in Deregulated Markets," *International Journal of Electrical and Computer Engineering*, vol. 1, p. 71, 2011.

[32]W. Y. Ng, "Generalized Generation Distribution Factors for Power System Security Evaluations," *IEEE Transactions on Power Apparatus and Systems*, vol. PAS-100, pp. 1001-1005, 1981.

[33]Matpower, "Matpower 6.0 User's Manual," <http://www.pserc.cornell.edu/matpower/manual.pdf>, 2016.

[34]H. Oh, "A New Network Reduction Methodology for Power System Planning Studies," *IEEE Transactions on Power Systems*, vol. 25, pp. pp. 677-684, May 2010.

[35]N. D. G. a. K. L. Thakre, "2006 International Conference on Power Electronic, Drives and Energy Systems," *Application of Power Flow Sensitivity Analysis and PTDF for Determination of ATC*, pp. pp. 1-7, 2006.

[36]M. Andoni, V. Robu, W.-G. Früh, and D. Flynn, "Game-theoretic modeling of curtailment rules and network investments with distributed generation," *Applied Energy*, vol. 201, pp. 174-187, 9/1/ 2017.

[37]C. Gu, F. Li, and Y. He, "Enhanced long-run incremental cost pricing considering the impact of network contingencies," *Power Systems, IEEE Transactions on*, vol. 27, pp. 344-352, 2012.



Xiaohe Yan (S'16) was born in Shaanxi, China. He obtained Bachelor degree in electrical engineering from Xi'an University of Technology, in 2013, and Master degree from University of Bath, UK, in 2015. Currently, he is pursuing the Ph.D degree at the University of Bath, UK. His major research interest is in the area of power system planning, analysis, and power system economics.

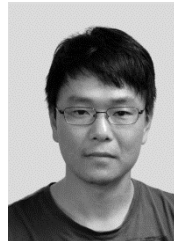

Chenghong Gu (M'14) was born in Anhui province, China. He obtained Bachelor degree and Master degree in electrical engineering from Shanghai University of Electric Power and Shanghai Jiao Tong University in China in 2003 and 2007 respectively. In 2010, he obtained his Ph.D. from University of Bath, U.K. Now, he is a Lecturer and EPSRC fellow with the Dept. of Electronic & Electrical Eng., University of Bath, UK. His major research is in multi-vector energy system, smart grid and power economics.



Furong Li (SM'09) received the B.Eng. degree in electrical engineering from Hohai University, Nanjing, China, in 1990, and the Ph.D. degree from Liverpool John Moores University in 1997 with a dissertation on applications of genetic algorithms in optimal operation of electrical power systems. She is currently a Professor and the Director of the Center for Sustainable Power Distribution, University of Bath, Bath, U.K. Her major research interest is in the area of power system planning, analysis, and power system economics.



Zhaoyu Wang (S'13-M'15) is the Harpole Pentair Assistant Professor with Iowa State University. He received the B.S. and M.S. degrees in electrical engineering from Shanghai Jiaotong University in 2009 and 2012, respectively, and the M.S. and Ph.D. degrees in electrical and computer engineering from Georgia Institute of Technology in 2012 and 2015, respectively. He was a Research Aid at Argonne National Laboratory in 2013, and an Electrical Engineer at Corning Inc. in 2014. His research interests include power distribution systems, microgrids, renewable integration, power system resiliency, demand response and voltage/VAR control.